



Architectural Door & Cabinet Door

Workshop: 337 B Quintana Road, Morro Bay, CA 93442 | Mailing: P.O Box 826, Morro Bay, CA 93443

Email: tydix@tydix.com | Phone: (805) 771-9067 | Fax: (805) 771-9069



TYDIX Flush Pulls

TYDIX Flush Pulls are ground and polished to furnish a square, flat dress face usually free of blemishes. All outside edges and corners are clean and sharp in appearance. Important inside surfaces are smoothed to a practical degree. All inside corners of the dress face are filed to full, sharp, square corners.

TYDIX Flush Pulls are available in a considerable variety of finishes and finish combinations. That is, the hardware finish of the dress face may be contrasted with, or complemented by, the color treatment inside the frame and/or color or finish of the back plate.

Accordingly, there are three “areas” where your color plans might be carried out: the Dress Face, inside the Frame, and the Back Plate. The following lists finishes or colors which might apply to each of these areas:

FLUSH PULL FINISHES

Dress Face Finish	Symbol	Inside Frame Color	Symbol
Polished Brass	US 3	Satin Black	Blk.
Satin Brass	US 4	Brass Spray	236
Polished Bronze	US 9	Bronze Spray	277
Satin Bronze	US 10	Dark Bronze Spray	275
Oil-Rubbed Bronze	US 10B	Chrome Spray	266
Polished Nickel	US 14		
Satin Nickel	US 15		
Polished Chrome	US 26		
Satin Chrome	US 26D		
Statuary Bronze	Specify		
Antique Bronze	Specify		
Satin Black	Specify		

Flush Pull No.	Dress Face	Inside Frame	Back Plate	Other		
610064	US 10B	x	Blk.	x	Blk.	TMP (temperproof screws)
610063	US 10B	x	275	x	US 10B	
610064	US 10	x	277	x	Blk.	

Workshop: 337 B Quintana Road, Morro Bay, CA 93442 | Mailing: P.O Box 826, Morro Bay, CA 93443

Email: tydix@tydix.com | Phone: (805) 771-9067 | Fax: (805) 771-9069

FLUSH PULL FINISHES

Metal

Same as Dress Face

(Satin finishes recommended)

Counter top Laminates

Satin Black

Other Color or Texture (Customer to Supply)

Symbol

Blk.

Specify



TYDIX Flush Pulls

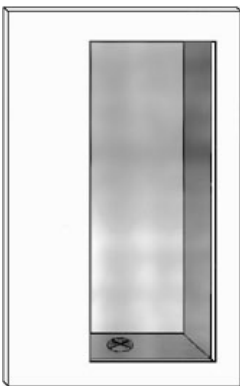

No. 61064
4" X 2-1/2"

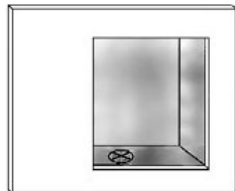

No. 61063
2" X 2-1/2"

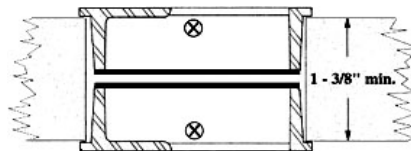

**Two Pulls
One Door**



**Single Pull for Doors and
Drawers**

Specify: Flush pull number
Hardware finish of Face
Color inside Frame
Back Plate color
(Example: No. 61064,
US 10B X Blk.)

Specify: TMP for tamperproof
screws
(Full flush installation
of pulls is not recom-
mended.)

A3

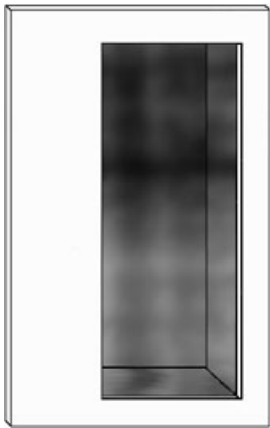

No. 72075 - TBI
4" X 2-1/2"

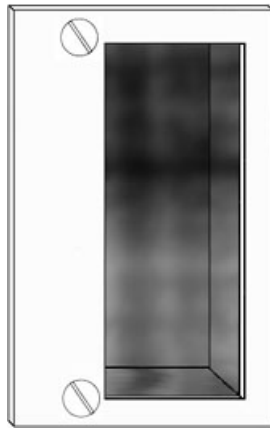

No. 72075 - BB2
4" X 2-1/2"

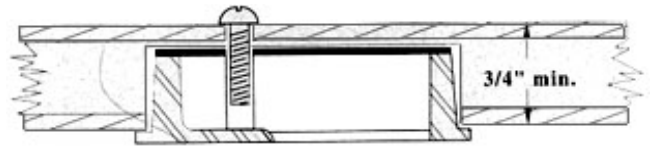

Single Pulls for Hollow Metal
72075 - TBI

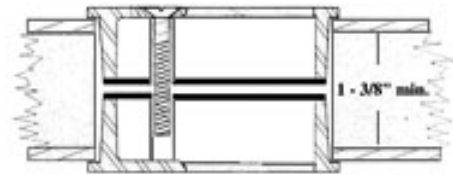

Back-to-Back Pulls for Hollow Core Doors
72075 - BB2 / 72075 - TBI

A5



For Drawers No. 2045
4-1/2" x 2-3/8"



Top View
2045

A6

Locking Pulls for Drawers

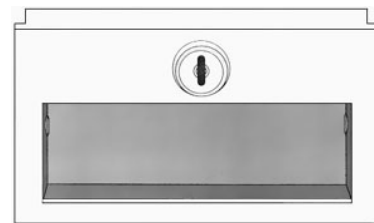
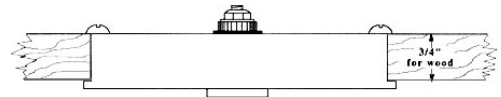

No. LK1 - 2045
4-1/2" x 2-3/8"

NOTE: Flush pull No. LK1-2045 Dress Face is available in chrome or nickel only

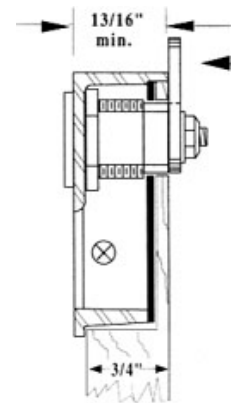

TYDIX Edge Pulls

Tydix Edge Pulls are handmade (not extrusions), fabricated to your design concepts, made to order to any door thickness, overlay or clearance . Meets ADA requirements.

The material used in Tydix Edge Pulls is solid brass or bronze, and any standard hardware finish except aluminum or stainless steel, are available.

Fabrication Specifications Include:

- Desired roll diameter (see B-5)
- Desired roll length (1-1/4" through 24")
- Desired style (see pages B-2 through B-4)
- Desired finish (see page B-5)
- RC for rounded roll ends

(Examples: BR 1/4" x 1-1/2, US 26, RC-SR 5/16 x 3, US 10B, DAF 3/8 x 4, US 10)

To order furnish the above information plus the following:

Thickness of basic door or drawer (screws will be located accordingly, or per a provided drawing)

Thickness of any overlay (mirror, panel, etc.)

Clearance desired if other than standard (1/2")

Overall dimension (OA) if important. (OA = door thickness + overlays + clearance + roll diameter)

Angle of door bevel (types SAR and SAF) or other angles required (standard is 1/8" in 2")

Finish (see page B-5)

Note: a simple sketch can be invaluable

For Pricing & Lead-time:

Call 805.771 9067

Or email tydix@tydix.com

Provide fabrication specifications above at time of quote.

Workshop: 337 B Quintana Road, Morro Bay, CA 93442 | Mailing: P.O Box 826, Morro Bay, CA 93443

Email: tydix@tydix.com | Phone: (805) 771-9067 | Fax: (805) 771-9069

B2

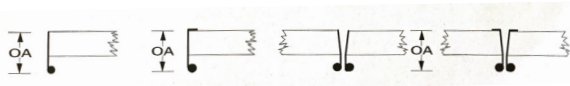
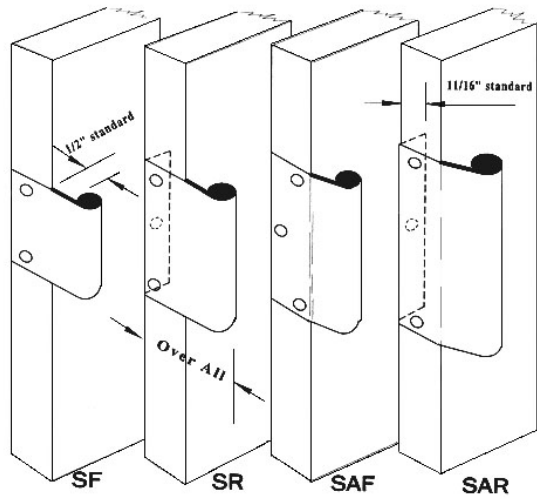

B3

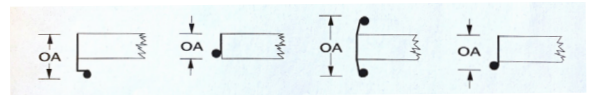
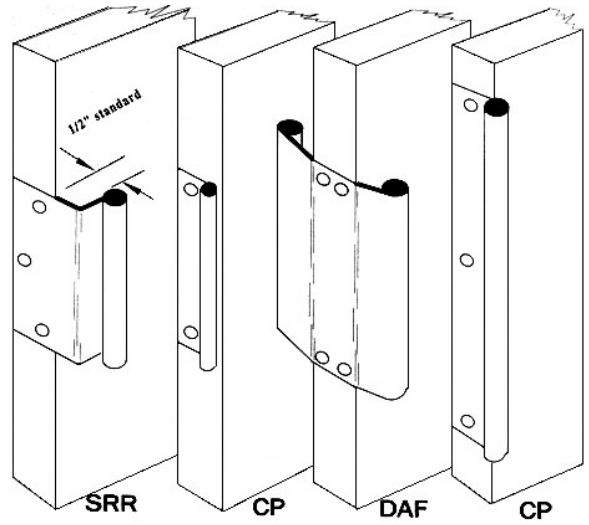

B4

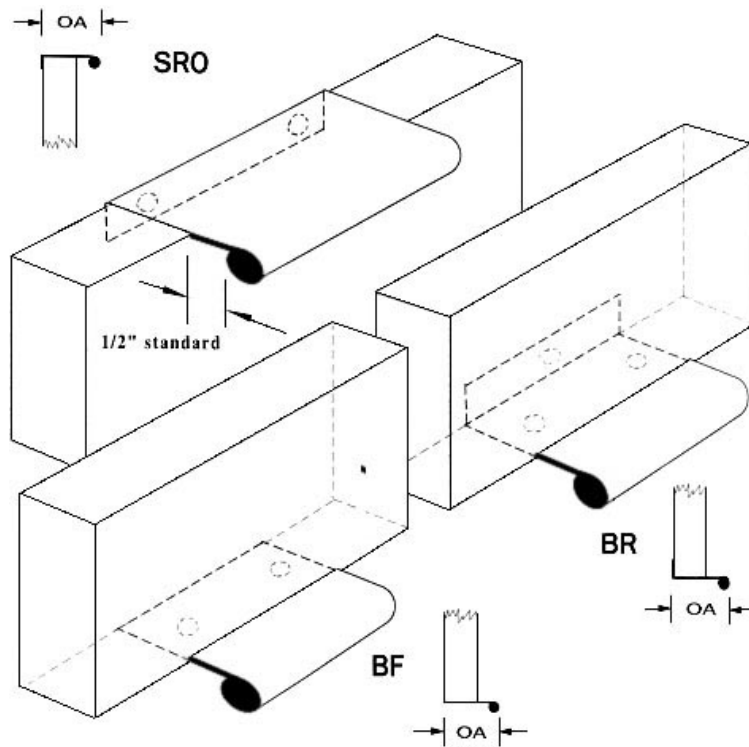

B5

Roll Diameters

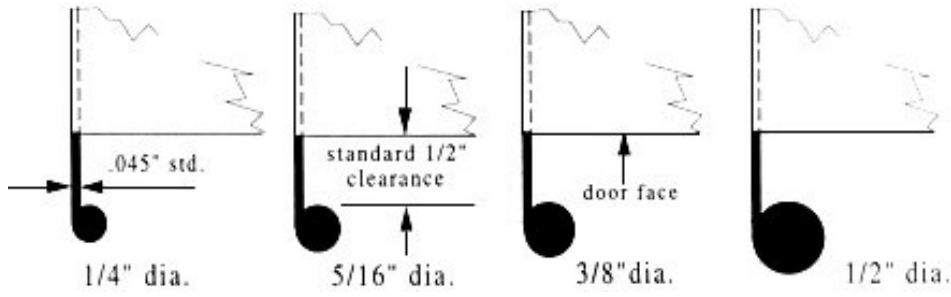

EDGE PULL FINISHES

	Symbol
Polished Brass	US 3
Polished Brass (no lacquer)	US 3NL
Satin Brass	US 4
Polished Bronze	US 9
Satin Bronze	US 10
Oil-Rubbed Bronze	US 10B
Polished Nickel	US 14
Satin Nickel	US 15
Polished Chrome	US 26
Satin Chrome	US 26D
Antique Nickel	Specify
Antique Bronze	Specify
Statuary Bronze	Specify
Satin Black	US 19
Polish Black Chrome	Specify
Antique Brass	Specify
Gold	Specify

*****Inquire About Other Custom Finish*****

Workshop: 337 B Quintana Road, Morro Bay, CA 93442 | Mailing: P.O Box 826, Morro Bay, CA 93443

Email: tydix@tydix.com | Phone: (805) 771-9067 | Fax: (805) 771-9069



TYDIX Door Pulls

TYDIX Door Pulls are designed for use on tempered glass, hollow-metal or wood, or solid wood doors. All door pulls can be installed either back-to-back or one side only. Door pulls are internally screwed together; no set screws are needed.

TYDIX Door Pulls are constructed from 7/8" diameter solid stainless steel, brass, or bronze. TYDIX Door Pulls are available in all the standard hardware finishes listed on page A-1 plus US 32 (polished stainless steel) and US 32D (satin Stainless steel).

Three basic door pull styles are available and are shown on pages C-4 through C-7.

There are four base styles used in installing TYDIX Door Pulls:

No. 0 Base	7/8" diameter x 5/8"
No. 1 Base	1" diameter x 5/8"
No. 2 Base	1-1/4" diameter x 5/8"
No. 3 Base	7/8" diameter x 1/4" (for tempered glass)

Pages C-2 through C-7 illustrate through bolts, door pull styles, possible base and door pull combinations, and systems for back-to-back or one-side-only installations.

TYDIX Door Pulls SECURITY SYSTEMS

Flush Head - Through Bolts

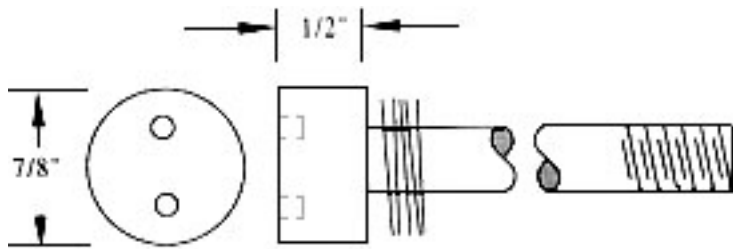

TYPE SH-1

(Furnished with .010" thick packing washers for adjusting to full flush. For wood doors.)

Surface Head - Through Bolts

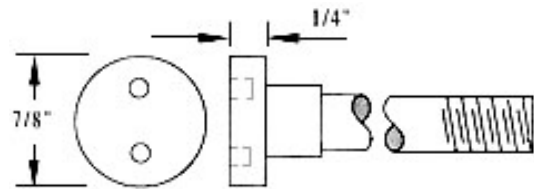

TYPE SH-3

(Spamer Head for Tempered Glass)

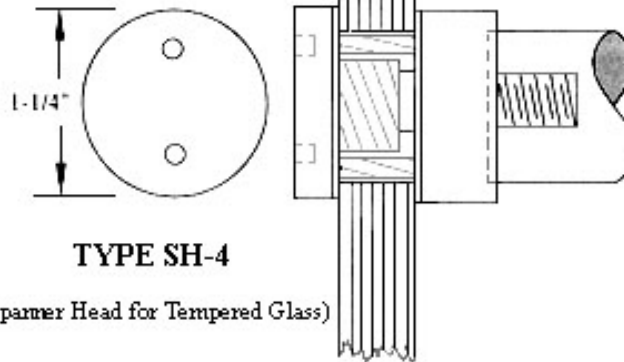

TYPE SH-4

(Spamer Head for Tempered Glass)

TYDIX Door Pulls SECURITY SYSTEMS

DOOR PULLS ARE INTERNALLY SCREWED TOGETHER - No Set Screws
ONE-SIDE-ONLY INSTALLATION

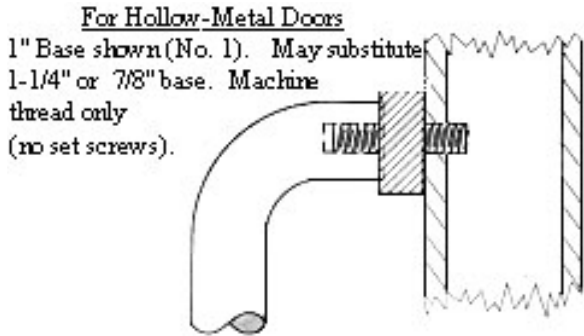

TYPE MLB (Metal Blind)

The drawings on this page are intended to show standard systems used with the 78000 series of door pulls. (See C-4 through C-7.) Each system type is available with most TYDIX Door Pulls.

BACK-TO-BACK INSTALLATION

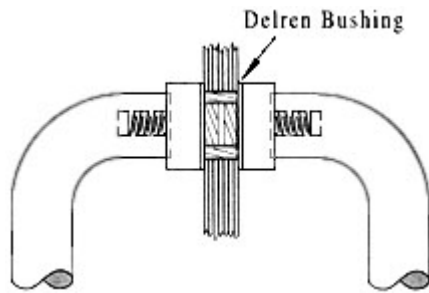

For Tempered Glass Doors

For Hollow-Metal or Wood doors
1-1/4" Base shown (No. 2); requires a 7/8" hole in glass. May substitute 7/8" base (No. 3); requires 5/8" hole. Machine thread only (no set screws).

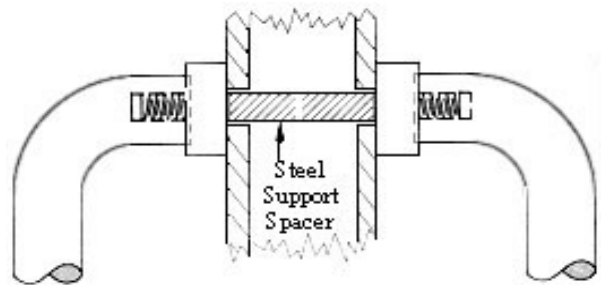

For Hollow-Metal or Wood doors

1-1/4" Base shown (no. 2) > May substitute 1" or 7/8" base.



TYDIX Door Pulls SECURITY SYSTEMS

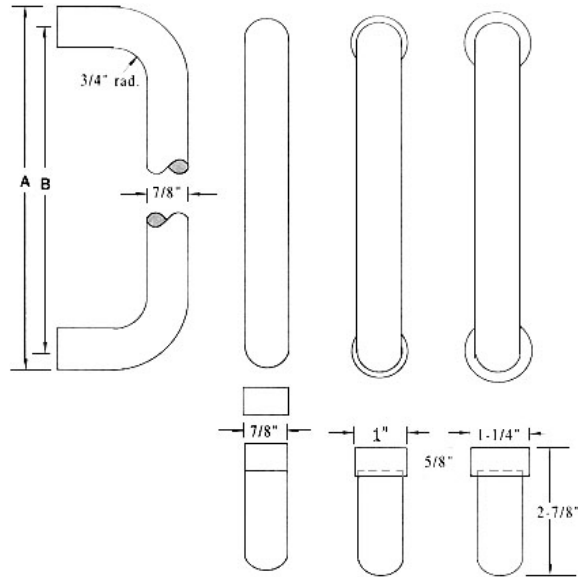

Length (A)	C to C (B)	Pull No. (With No. 0 Base)	Pull No. (With No. 1 Base)	Pull No. (With No. 2 Base)
9	8-1/8	78090	78091	78902
10-7/8	10	78100	78101	78102
12	11-1/8	78120	78121	78122
16	15-1/8	78160	78161	78162
24	23-1/8	78240	78241	78242
Variable	Specify	78300	78301	78302

Use for horizontal bar number in sets combining 1 vertical pull with 1 horizontal push bar.

Workshop: 337 B Quintana Road, Morro Bay, CA 93442 | Mailing: P.O Box 826, Morro Bay, CA 93443

Email: tydix@tydix.com | Phone: (805) 771-9067 | Fax: (805) 771-9069



TYDIX Door Pulls SECURITY SYSTEMS

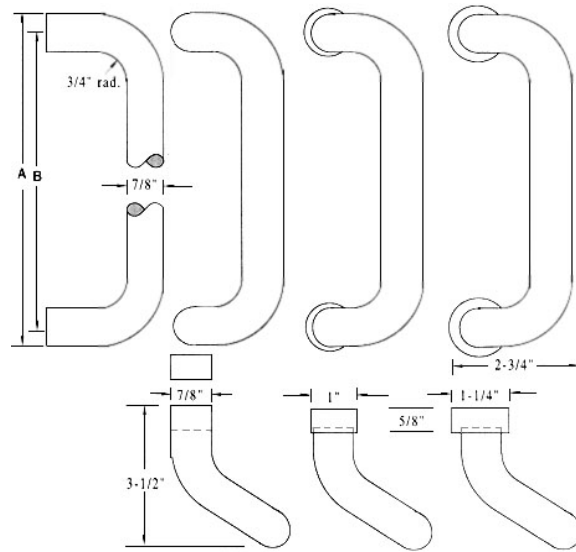

Length (A)	C to C (B)	Pull No. (With No. 0 Base)	Pull No. (With No. 1 Base)	Pull No. (With No. 2 Base)
9	8-1/8	78090-45	78091-45	78902-45
10-7/8	10	78100-45	78101-45	78102-45
12	11-1/8	78120-45	78121-45	78122-45
16	15-1/8	78160-45	78161-45	78162-45
24	23-1/8	78240-45	78241-45	78242-45

Workshop: 337 B Quintana Road, Morro Bay, CA 93442 | Mailing: P.O Box 826, Morro Bay, CA 93443

Email: tydix@tydix.com | Phone: (805) 771-9067 | Fax: (805) 771-9069



TYDIX Door Pulls SECURITY SYSTEMS

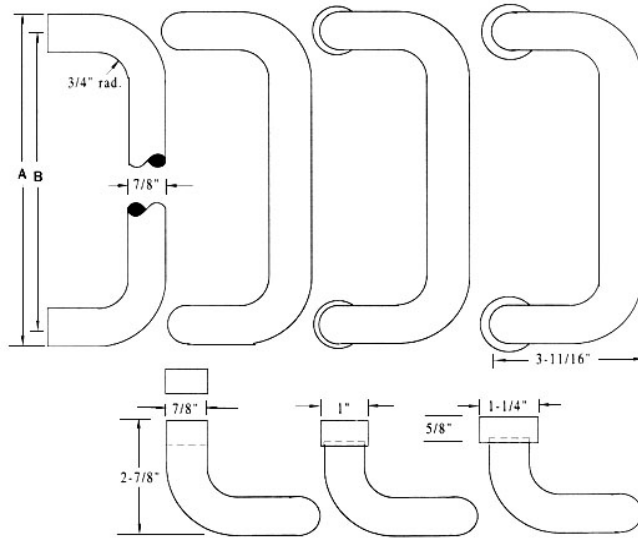

Length (A)	C to C (B)	Pull No. (With No. 0 Base)	Pull No. (With No. 1 Base)	Pull No. (With No. 2 Base)
9	8-1/8	78090-90	78091-90	78902-90
10-7/8	10	78100-90	78101-90	78102-90
12	11-1/8	78120-90	78121-90	78122-90
16	15-1/8	78160-90	78161-90	78162-90
24	23-1/8	78240-90	78241-90	78242-90

Workshop: 337 B Quintana Road, Morro Bay, CA 93442 | Mailing: P.O Box 826, Morro Bay, CA 93443

Email: tydix@tydix.com | Phone: (805) 771-9067 | Fax: (805) 771-9069



TYDIX Door Pulls SECURITY SYSTEMS

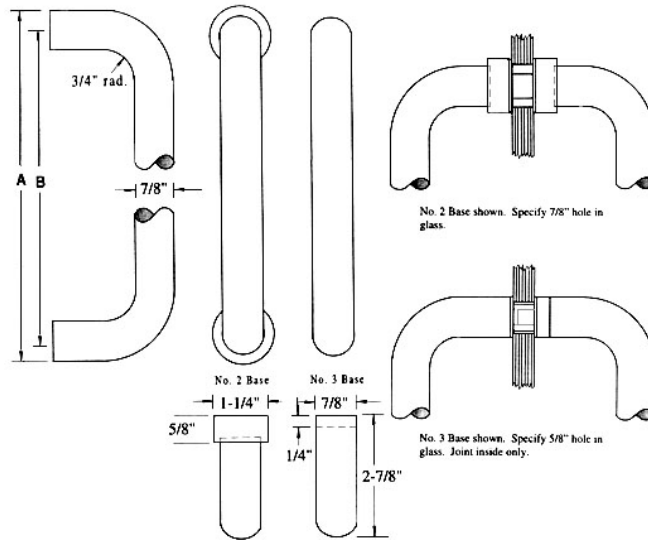

Length (A)	C to C (B)	Pull No.	Pull No.
		(With No. 2 Base)	(With No. 3 Base)
9	8-1/8	78092	78093
10-7/8	10	78102	78103
12	11-1/8	78122	78123
16	15-1/8	78162	78163
24	23-1/8	78242	78243
Variable	Specify	78302	78303

Workshop: 337 B Quintana Road, Morro Bay, CA 93442 | Mailing: P.O Box 826, Morro Bay, CA 93443

Email: tydix@tydix.com | Phone: (805) 771-9067 | Fax: (805) 771-9069